

**Micro HDMI INTERFACE CONTROLLER
FOR TFT PANEL**

Model: DD-1920-HDMI-T

Part number: 417570010-5

INSTRUCTIONS

CONTENTS

- Page: **2. Introduction, How to Proceed, Usage Note, Disclaimer**
3. System design – Diagram of a suggested system
4. Assembly notes – Important information about system elements
5. Connection & Operation – How to use the controller
9. Connectors, pinouts & jumpers – Essential connection information
15. Controller dimensions
16. Troubleshooting
17. Specifications
18. Appendix I – Mode Support Table
19. Appendix II – RS-232 control protocols
23. Appendix III – Appendix III – DDC/CI support at Micro HDMI port
24. Appendix IV - Mapping definition
26. Appendix V – DV remote control unit work for DD-1920-HDMI-T
27. Warranty, Caution & Limitation of Liability, Trademarks
28. Contact details

It is essential that these instructions are read and understood before connecting or powering up this controller.

Introduction

Designed for LCD monitor and other flat panel display applications, the DD-1920-HDMI-T controller provides easy to use Micro HDMI interface controller for:

- TFT (active matrix) LCDs with LVDS interface of 1920x1200, 1920x1080, 1920x480, 1680x1050, 1600x1200, 1400x1050, 1366x768, 1280x1024, 1280x800, 1280x768, 1024x768, 800x600, 800x480, 640x480, 480x640 resolution
- Support Micro HDMI input up to 1080p/WUXGA input resolution

Ordering information :

Controller	Part number	Ordering part number
DD-1920-HDMI-T	P/N 417570010-5	P/N 4175700XX-5

HOW TO PROCEED

- Ensure you have all parts & that they are correct, refer to:
 - Connection diagram (separate document for each panel)
 - Connector reference (in following section)
 - Assembly notes
- Check controller switch & jumper settings (errors may damage the panel)
- Prepare the PC
- Connect the parts
- Understand the operation and functions (in following section)

IMPORTANT USAGE NOTE

This product is for use by system developers and integrators, the manufacturer accepts no liability for damage or injury caused by the use of this product. It is the responsibility of the developer, integrators or other user of this product to:

- Ensure that all necessary and appropriate safety measures are taken.
- Obtain suitable regulatory approvals as may be required.
- Check power settings to all component parts before connection.
- Understand the operation and connectivity requirements of this controller.

DISCLAIMER

There is no implied or expressed warranty regarding this material.

SYSTEM DESIGN

A typical LCD based display system utilising this controller is likely to comprise the following:

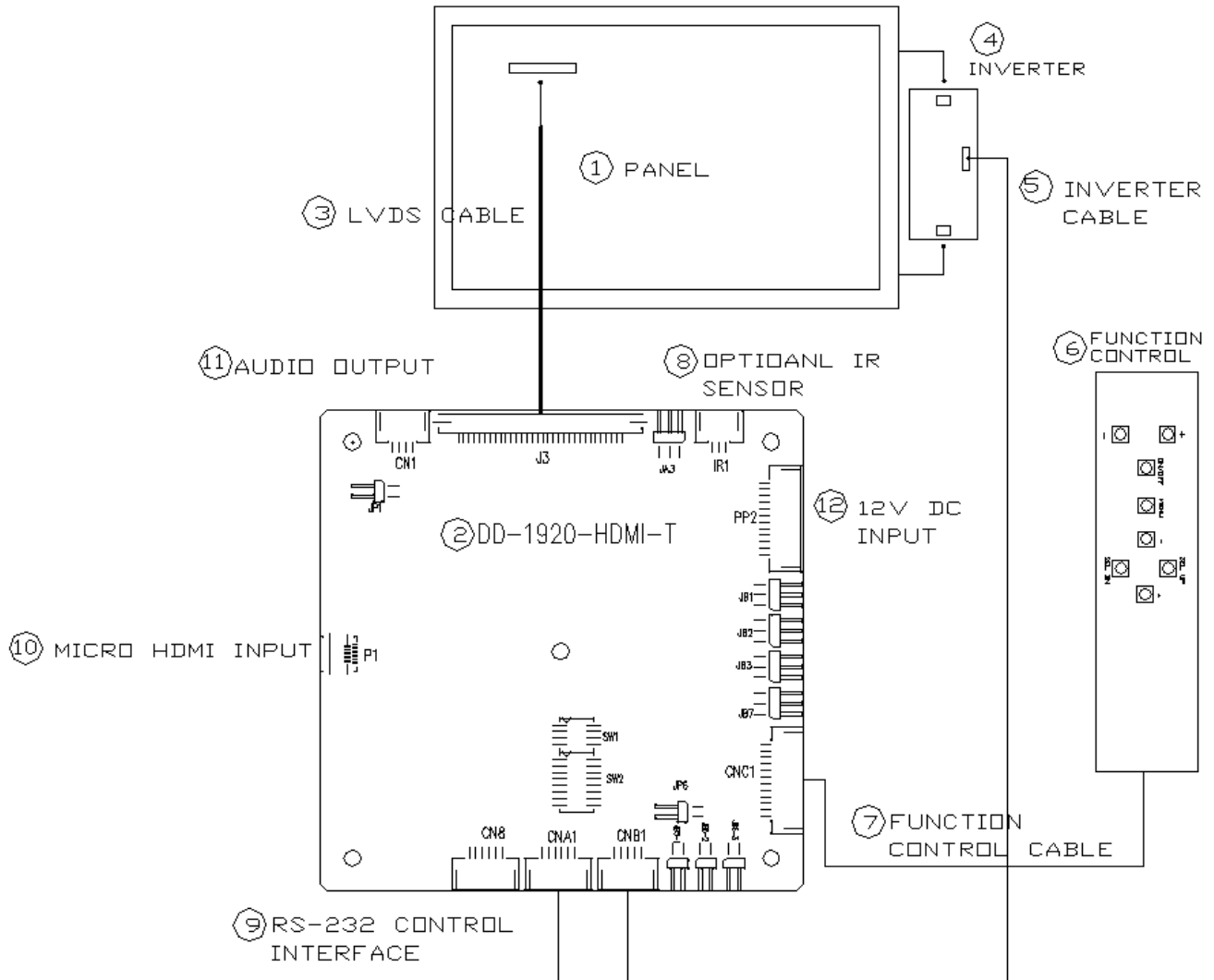

Summary:

1. LCD panel
2. LCD controller card, DD-1920-HDMI-T
3. LVDS cable (for connection with LVDS panel)
4. Inverter for LCD backlight (if not built into LCD)
5. Inverter cable
6. Function controls
7. Function controls cable
8. IR sensor (Optional)
9. RS-232 control interface
10. Micro HDMI signal source
11. Audio output (Stereo)
12. Power input (12VDC)

Digital View offers a range of accessories such as listed above, to make up complete display solution.

ASSEMBLY NOTES

This controller is designed for monitor and custom display projects using 1920 x 1200, 1920 x 1080, 1920 x 480, 1680x1050, 1600x1200, 1400x1050, 1440x900, 1366x768, 1280x1024, 1280x800, 1280x768, 1024x768, 1024x600, 800x600, 800x480, 640x480, 480x640 resolution TFT panels with a VGA, SVGA, XGA, SXGA, UXGA, WUXGA signal input. The following provides some guidelines for installation and preparation of a finished display solution.

Preparation: Before proceeding it is important to familiarize yourself with the parts making up the system and the various connectors, mounting holes and general layout of the controller. As much as possible connectors have been labeled. Guides to connectors and mounting holes are shown in the following relevant sections.

1. **LCD Panel:** This controller is designed for typical LVDS interface TFT panels with panel voltage 3.3V or 5V or 12V LVDS interface. Due to the variation between manufacturers of signal timing and other panel characteristics factory setup and confirmation should be obtained before connecting to a panel. **(NOTE: Check panel power jumper settings before connection)**
2. **Controller card:** Handle the controller card with care as static charge may damage electronic components.
3. **LVDS signal cable :** In order to provide a clean signal it is recommended that LVDS signal cables are no longer than 46cm (18 inches). If loose wire cabling is utilized these can be made into a harness with cable ties. Care should be taken when placing the cables to avoid signal interference. Additionally it may be necessary in some systems to add ferrite cores to the cables to minimize signal noise.
4. **Inverter:** This will be required for the backlight of an LCD, some LCD panels have an inverter built in. As panels may have 1 or more backlight tubes and the power requirements for different panel models backlights may vary it is important to match the inverter in order to obtain optimum performance. See page 15 for the Application notes "Inverter connection section for more informations.
5. **Inverter Cables:** Different inverter models require different cables and different pin assignment. Make sure correct cable pin out to match the inverter. Using wrong cable pin out may damage the inverter.
6. **OSD switch mount controls:** The following section discusses the controls required and the section on connectors provides the detail. The controls are minimal: On/Off, Backlight Brightness (depends on inverter), OSD (5 momentary buttons) analog VR type or (8 momentary buttons) digital type.
7. **OSD switch mount controls cable:** The cables to the function switches should be of suitable quality and length so that impedance does not affect performance. Generally lengths up to 1 metre (3 feet) should be acceptable.
8. **IR sensor:** It is an optional part only, can be unconnected if not using IR remote control. See Appendix V for button definition.
9. **RS-232 control interface:** Firmware upgrade and serial control via this interface port.
10. **Micro HDMI input:** Support Micro HDMI input up to 1080p/WUXGA resolution. Plug the Micro HDMI cable to the connector P1 on the controller board.
11. **Audio output (Stereo) from Micro HDMI :** This port support Stereo audio output (no amplification) from the Micro HDMI audio source inputted. It requires to select the audio port "Speakers" via OSD menu under "Sound" > "Output" OSD menu page.
12. **Power Input:** 12VDC is required, this should be a regulated supply. Although the controller provides power regulation for the LCD power this does not relate to the power supplied to the backlight inverter. If an unregulated power supply is provided to an inverter any fluctuations in power may affect operation, performance and lifetime of the inverter and or backlight tubes.
 - **Power Safety:** Note that although only 12VDC is supplied as 'power-in' a backlight inverter for panel backlighting produces significantly higher voltages (the inverter does not connect to the ground plane). We strongly advise appropriate insulation for all circuitry.
 - **EMI:** Shielding will be required for passing certain regulatory emissions tests. Also the choice of external Controller to PC signal cable can affect the result.
 - **Ground:** The various PCB mounting holes are connected to the ground plane.
 - **Servicing:** The board is not user serviceable or repairable. Warranty does not cover user error in connecting up to the controller and is invalidated by unauthorized modification or repairs.
 - **Controller Mounting:** It is recommended that a clearance of at least 10mm is provided above and 5mm below the controller when mounted. Additionally consideration should be given to:
 - Electrical insulation.
 - Grounding.
 - EMI shielding.
 - Cable management. Note: It is important to keep panel signal cables apart from the inverter & backlight cables to prevent signal interference.
 - Heat & Ventilation: Heat generated from other sources, for example the backlight of a very high brightness panel may generate significant heat which could adversely affect the controller.
 - Other issues that may affect safety or performance.

IMPORTANT: Please read the Application Notes section for more information

CONNECTION & OPERATION

CAUTION: Never connect or disconnect parts of the display system when the system is powered up as this may cause serious damage.

CONNECTION

Connection and usage is quite straight forward (it is useful to have the relevant connection diagram available at this time):

LCD panel & Inverter: Connect the inverter (if it is not built-in the panel) to the CCFT lead connector of the LCD panel.

LVDS type panels: Plug the LVDS signal cable direct to J3. Insert the panel end of the cable to the LCD panel connector.

Inverter & Controller: Plug the inverter cable to CNB1 and CNA1 (if necessary). Plug another end to the connector on the inverter.

Function switch & Controller: Plug the OSD switch mount cable to CNC1 on the controller board and another end to the OSD switch mount.

LED 1 : Plug in a 3-way with dual colour LED to connector LED1 on the controller board for indicating the controller status.

IR & Controller: Plug in a 3-way with IR sensor to connector IR1 on the controller board.

Jumpers : Check all jumpers are set correctly. Details referring the connection diagram.

Jumpers & Inverter & Panel voltage: Particularly pay attention to the settings of JA3, JB1, JB2, JB3. JB2 & JB3 are used for inverter control (read inverter specification and information on the jumper table to define the correct settings). JA3 is used for panel voltage input (read panel specification and information on the jumper table to define the correct settings).

Micro HDMI cable : Plug the Micro HDMI cable to the connector P1 on the controller board.

SPDIF audio connector : audio output ports CN11 supports audio SPDIF audio output from Micro HDMI audio source inputted. It requires to select the audio port "SPDIF" via OSD menu under "Sound" > "Output" OSD menu page.

Audio output (Stereo) from Micro HDMI : audio output port CN1 supports Stereo audio output (no amplification) from the Micro HDMI audio source inputted. It requires to select the audio port "Speakers" via OSD menu under "Sound" > "Output" OSD menu page.

Power supply & Controller: Plug the DC 12V power in to the connector PP2.

Power on: Switch on the controller board and panel by using the OSD switch mount.

CAUTION: Never connect or disconnect parts of the display system when the system is powered up as this may cause serious damage.

Controller LED status (LED1) :

State	LED color
No signal & backlight off	RED
No signal & backlight on	ORANGE
With signal & backlight on	GREEN

General:

- If you are using supplied cables & accessories, ensure they are correct for the model of panel and controller.
- If you are making your own cables & connectors refer carefully to both the panel & inverter specifications and the section in this manual, "Connectors, Pinouts & Jumpers" to ensure the correct pin to pin wiring.

OPERATION

Once the system has been connected and switched on there are a number of functions available to adjust the display image as summarized in the following sections. The settings chosen will be saved for each mode independently.

LCD DISPLAY SYSTEM SETTINGS

NOTE: By way of explanation the following refers to a set of sample buttons that may be obtained as an option. In addition to power on/off and connection for backlight brightness the controller provides an On Screen Display of certain functions which are controlled by 5 momentary type buttons (analog VR type) or 8 momentary type buttons (digital type):

Controls	Analog VR type	Digital type
On/Off – turns controller board power on	VR toggle switch	On/Off button
Brightness – controls backlight brightness	Rotary VR	Brightness +/- buttons
Menu – turns OSD menu On or Off (it will auto time off) (Function with signal input only)	Menu button	Menu button
Select – Select function / Confirm (under OSD menu on state)	SEL DN	SEL DN
Move up to select individual RGB color level OSD page (under OSD menu on state)	SEL UP	SEL UP
+ – increase the setting / moves the selector to the next function (under OSD menu on state)	+	+
- - decrease the setting / moves the selector to the previous function (under OSD menu on state)	-	-
Reset to Factory Defaults	Press and hold SEL DN button, then power on the controller	Press and hold SEL DN button, then power on the controller
Switch to next input source (under OSD menu off state)	+	+

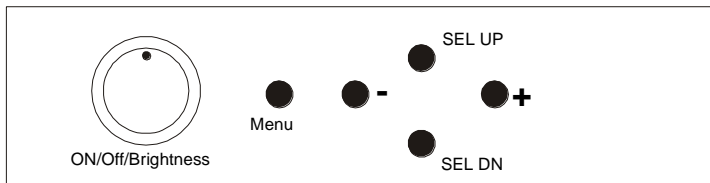

Analog VR type

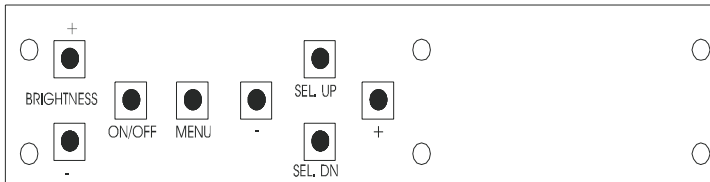

Digital type













OSD Functions

Image	
	<p>Brightness Increase/decrease brightness level. Press – or + (- <input type="text"/> +) Total : 100 steps</p>
	<p>Contrast Increase/decrease contrast level. Press – or + (- <input type="text"/> +) Total : 100 steps</p>
	<p>Sharpness Increase/decrease sharpness level. Press – or + (- <input type="text"/> +) Total : 8 steps</p>
	<p>Color Color temp ▶ (Adjust the warmth of the image displayed. The higher temperature the coolest image looks like. The lower temperature the warmest image looks like.)</p> <p>4200k 5000k 6500k 7500k 9300k User ▶</p> <p>R Press – or + (- <input type="text"/> +) Total : 100 steps G Press – or + (- <input type="text"/> +) Total : 100 steps B Press – or + (- <input type="text"/> +) Total : 100 steps</p> <p> Reset</p> <p>Gamma (0.4/0.6/1.0/1.6/2.2)</p>
Display	
	<p>Backlight** ▶</p>
	<p>Invert B/L Invert : Invert for the backlight brightness</p>
	<p>Control D/A / PWM : Selection for voltage level dimming control / PWM dimming control</p>
	<p>Frequency Backlight frequency 100 ~ 440Hz in a step of 20</p>
	<p>B/L Backlight brightness adjustment</p>
1280 1366	<p>Widescreen mode ▶</p>
	<p>DDC programming Video timing CVT timing</p>

[Please refer to application note for this function details]

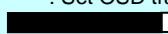

		Sound	
		Mute	Mute
		Output	Select audio output port Speakers : via CN1 & J1 connector SPDIF : via CN11 connector
		System	
		Timer : OSD Timeout in seconds 3 sec 6 sec 12 sec Always On	
		Rotation : OSD menu rotation in degree 0 90 180 270	
		Position : Adjust OSD menu position	
		Transparency : Set OSD transparency Press – or + () Total : 100 steps	
		Reset : Load factory default settings. Press down on OSD keypad to factory reset	

[Firmware version : V1.07.00 or up]

Remark :

Items marked ▶ have sub menus.

Exit the OSD menu to save the setting chosen

CONNECTORS, PINOUTS & JUMPERS

The various connectors are:

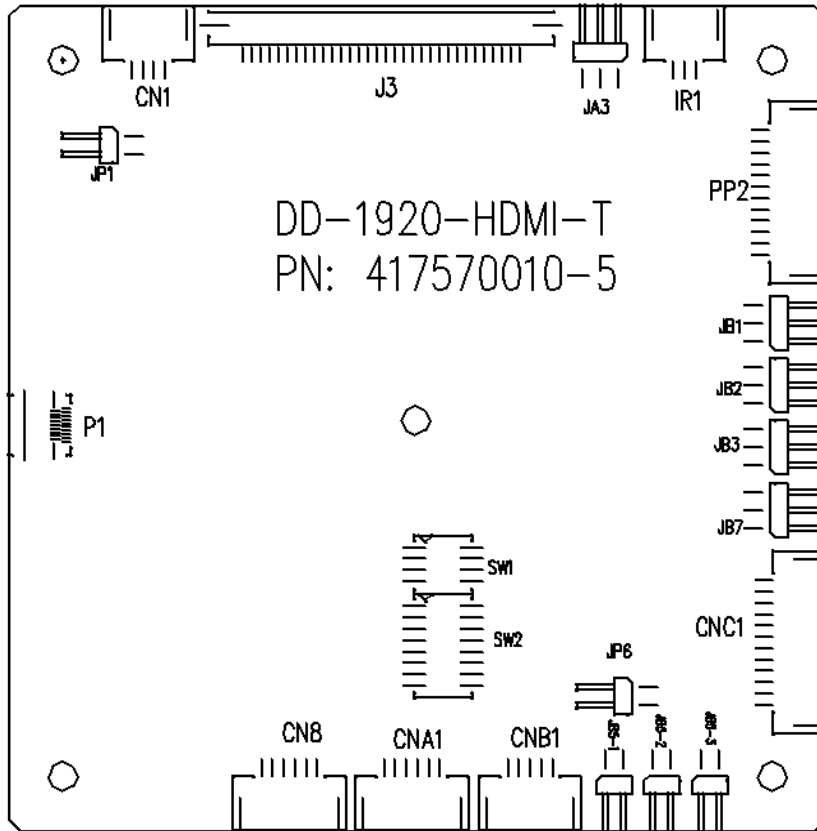



Summary: Connectors

Ref	Purpose	Description
CN1	Audio output (Stereo) from Micro HDMI	12513WR-04
CN8	Serial control	12513WR-06
CNA1	Auxiliary power output	12513WR-06
CNB1	Backlight inverter	12513WR-06
CNC1	OSD controls	12513WR-12
IR1	Infra-Red sensor connector	12513WR-03
P1	Micro HDMI signal input	Micro HDMI
J3	LVDS panel signal	FI-X30SSLA-HF
PP2	Power input	12513WR-12

Summary: Jumpers setting

Ref	Purpose	Note
JA3	Panel power voltage select	See panel voltage setting table 1 CAUTION: Incorrect setting will cause panel damage
JB1	Backlight brightness voltage range	1-2 closed = 3.3V max 2-3 closed = 5V max
JB2	Backlight inverter on/off control – signal level	1-2 = On/Off control signal 'High' = +12V 2-3 = On/Off control signal 'High' = +5V Open = On/Off control signal 'High' = Open collector CAUTION: Incorrect setting can damage inverter.
JB3	Backlight inverter on/off control – polarity	1-2 = control signal 'high' = CCFT ON 2-3 = control signal 'low' = CCFT ON
JB5	Backlight control type selection	JB5-1 = VR/Digital switch mount control JB5-2 = Analog backlight brightness control via RS-232 command (0xe0) – voltage range 0~5V JB5-3 = PWM (Pulse Width Modulation) brightness
JP1	Reserved	Reserved for internal programming use (Always 1-2 closed)
JP6	Input power control	Short = External switch control Open = Switch mount control
JB7	Backlight control voltage on CNB1 pin4 (Function when JB5-1 sets closed)	Open = For OSD switch mount control (Default) 1-2=0V 2-3=3.3V/5V controlled by JB1
SW1	Panel selection	See table below
SW2	Panel selection	See table below

Table 1 : Panel voltage setting table :

Input voltage via PP2	Panel Voltage	JA3	Jumper on board
12VDC	3.3V	1-2 closed	
	5V	2-3 closed	
	12V	OPEN	

CAUTION: Incorrect setting can damage panel & controller

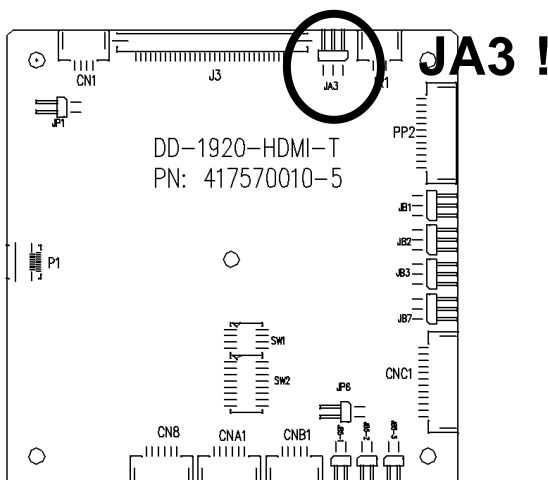



DIP Switch selection – SW2

Pos #1	Pos #2	Pos #3	Pos.#4	Description	Panel resolution
For WUXGA panel					
OFF	OFF	OFF	OFF	Samsung LTM220CS01 AU Optronics B170UW02 V0	1920x1200 1920x1200
ON	OFF	OFF	OFF	AU Optronics M215HW01 Samsung LTM230HT01	1920x1080 1920x1080
OFF	ON	OFF	OFF	Samsung LTI400HA01	1920x1080
For UXGA panel					
ON	OFF	OFF	OFF	NEC NL160120BC27-14	1600x1200
For WXGA panel					
ON	OFF	OFF	OFF	Samsung LTA260W2-L01	1366x768
ON	ON	OFF	OFF	Samsung LTA460WS-L03	1366x768
OFF	OFF	ON	OFF	Sharp LQ315T3LZ24 / AU Optronics M156XW01 V0	1366x768
ON	OFF	ON	OFF	LG LC420W02-A4	1366x768
OFF	ON	ON	OFF	NEC NL12880BC20-02D	1280x800
OFF	ON	OFF	OFF	NEC NL12876BC26-21	1280x768
ON	ON	ON	OFF	AU Optronics M220EW01	1680x1050
For SXGA panels					
ON	OFF	OFF	ON	NEC NL128102BC29-01B	1280x1024
ON	ON	ON	OFF	Fujitsu FLC48SXC8V	1280x1024
OFF	ON	OFF	ON	Sharp LQ181E1LW31	1280x1024
ON	ON	OFF	ON	Samsung LTM170ET01	1280x1024
OFF	OFF	ON	ON	AU Optronics M190EG01	1280x1024
For XGA panel					
OFF	OFF	ON	ON	AUO M150XN07 V2	1024x768
OFF	ON	ON	OFF	LG LM151X2	1024x768
ON	ON	OFF	ON	Sharp LQ150X1LGB1 Sharp LQ150X1LGN2A	1024x768 1024x768
ON	OFF	ON	ON	NEC NL10276BC12-02	1024x768
OFF	ON	ON	ON	NEC NL10276BC13-01C	1024x768
ON	ON	ON	ON	NEC NL10276BC30-18/ 30-18C NEC NL10276BC20-08	1024x768 1024x768
For SVGA panel					
OFF	OFF	ON	OFF	PrimeView PD104SL5H2 Sharp LQ121S1DG11 Sharp LQ104S1DG21 Sharp LQ121S1DG41	800x600 800x600 800x600 800x600
ON	OFF	ON	OFF	Toshiba LTM12C289	800x600
OFF	ON	ON	OFF	Sharp LQ084S3DG01	800x600
ON	ON	OFF	OFF	Sharp LQ121S1LG41 NEC NL8060BC21-02	800x600 800x600
ON	ON	ON	OFF	Sharp LQ104S1DG21	800x600
OFF	OFF	OFF	ON	PrimeView PD104SL5	800x600
ON	OFF	OFF	ON	NEC NL8060BH18-02	800x600
For WVGA panel					
ON	OFF	ON	OFF	NEC NL8048BC19-02	800x480
ON	OFF	OFF	ON	Sharp LQ070Y3LG4A	800x480
Others					
ON	OFF	OFF	ON	Samsung LTI430LA01	1920x480
ON	ON	ON	OFF	AU Optronics M200RW01 V1	1600x900
ON	OFF	OFF	OFF	Sharp LQ150F1LH22	1400x1050
ON	ON	OFF	OFF	Samsung LTM190M2-L31	1440x900
ON	OFF	ON	OFF	LG LM171WX3-TLA1	1440x900
OFF	ON	ON	OFF	LG LM171WX3	1440x900
OFF	OFF	ON	OFF	CPT CLAA102NA0ACW	1024x600

For additional and recent added panels, please contact us to support.



Pos #5	Pos #6	Pos #7	Description
OFF	OFF	OFF	WUXGA
ON	OFF	OFF	UXGA
OFF	ON	OFF	SXGA
ON	ON	OFF	WXGA
OFF	OFF	ON	XGA
ON	OFF	ON	SVGA
OFF	ON	ON	VGA / WVGA
ON	ON	ON	Others

SW1 Pos 8 = Reserved.

DIP switch selection – SW1

Pos. #	Function	Description
1	Panel pixel format	OFF : Double Pixel ON : Single Pixel
2	LVDS data mapping select	ON : Mapping A (LVDS panel) OFF : Mapping B (LVDS panel) Please adjust to get the correct picture. See as Appendix III for details of mapping A and B.
3	Reserved	Reserved
4	Operating mode selection	OFF : General application ON : Work with RM-DN5 (firmware version E1.12.10a) from Micro HDMI port [#]

Remark :

- # Assign SW1 position 4 to ON for connection to RM-DN5 (Firmware version : E1.12.10a) from Micro HDMI port with the following changes :
- Add "Loading..." message on screen while startup and stay until the valid signal.
 - Changed the default Auto Source Seek to Off
 - Changed the IR key from "Display" key to "OSD Next" key for menu function
 - Extend longer delay time approx. (4 secs) to detect signal for "No Signal" state
 - Only Micro HDMI input and disabled all other "Source" selections in OSD, IR hotkeys & RS-232 for RM-DN5 mode



CN1 – Audio output (Stereo) from Micro HDMI : YEONHO 12513WR-04

PIN	SYMBOL	DESCRIPTION
1	AMP L-	Audio Left channel (Negative)
2	AMP L+	Audio Left channel (Positive)
3	AMP R-	Audio Right channel (Negative)
4	AMP R+	Audio Right (Positive)

CN8 – RS-232 serial control: YEONHO 12513WR-06

PIN	SYMBOL	DESCRIPTION
1	SDATA	Reserved
2	SCLK	Reserved
3	VCC	+5V
4	TXD	RS-232 Tx data
5	GND	Ground
6	RXD	RS-232 Rx data

CNA1 - Auxiliary power output: YEONHO 12513WR-06

PIN	SYMBOL	DESCRIPTION
1	AUX POWER	+12V DC, 500mA max
2	GND	Ground
3	GND	Ground
4	AUX 5V	+5V DC, 500mA max
5	NC	No connection
6	NC	No connection

CNB1 – Backlight inverter connector: YEONHO 12513WR-06

PIN	SYMBOL	DESCRIPTION
1	GND	Ground
2	VBKL	Backlight power supply, +12VDC, 3A max
3	BLCTRL	Backlight On/Off control signal (refer to JB2 & JB3)
4	BVR_WIP	Backlight brightness VR pin WIP
5	BVR_A	Backlight brightness VR pin A
6	NC	No connection

CNC1 – OSD switch mount control, YEONHO 12513WR-12

PIN	SYMBOL	DESCRIPTION
1	PSWIN	Power button A
2	SW_ON	Power button B
3	BVR_A	Backlight Brightness VR pin A
4	BVR_WIP	Backlight Brightness R pin WIP
5	BVR_B	Backlight Brightness VR pin B (470 ohm resistor to +5V Vcc)
6	GND	Ground
7	MENU	OSD menu
8	-/LEFT	OSD -/Left
9	+ /RIGHT	OSD +/Right
10	SEL_DN	OSD Select down
11	SEL_UP	OSD Select up
12	NC	No connection

IR1 – Infra-Red sensor connector: YEONHO 12513WR-03

PIN	SYMBOL	DESCRIPTION
1	GND	Ground
2	STDBY_Vcc	Stand by voltage
3	IR Data	IR data

J3 – LVDS output connector: JAE FI-X30SSL-HF

PIN	SYMBOL	DESCRIPTION
1	VDD (+12V)	+12V
2	VDD (+12V)	+12V
3	VDD (+12V)	+12V
4	GND	GND
5	VDD (3,3V/5V)	+3V3 / +5V (see JA3)
6	VDD (3,3V/5V)	+3V3 / +5V (see JA3)
7	VDD (3,3V/5V)	+3V3 / +5V (see JA3)
8	TXB3+	LVDS Data 3+
9	TXB3-	LVDS Data 3-
10	TXAC+	LVDS Clock+
11	TXAC-	LVDS Clock-
12	GND	GND
13	TXA2+	LVDS Data 2+
14	TXA2-	LVDS Data 2-
15	TXA1+	LVDS Data 1+
16	TXA1-	LVDS Data 1-
17	TXA0+	LVDS Data 0+
18	TXA0-	LVDS Data 0-
19	GND	GND
20	TXB3+	LVDS Extended Data 3+
21	TXB3-	LVDS Extended Data 3-
22	TXAC+	LVDS Extended Clock+
23	TXAC-	LVDS Extended Clock-
24	GND	GND
25	TXA2+	LVDS Extended Data 2+
26	TXA2-	LVDS Extended Data 2-
27	TXA1+	LVDS Extended Data 1+
28	TXA1-	LVDS Extended Data 1-
29	TXA0+	LVDS Extended Data 0+
30	TXA0-	LVDS Extended Data 0-

PP2 - Power supply : YEONHO 12513WR-12

PIN	SYMBOL	DESCRIPTION
1	VDD (+12V)	+12V
2	VDD (+12V)	+12V
3	VDD (+12V)	+12V
4	VDD (+12V)	+12V
5	VDD (+12V)	+12V
6	VDD (+12V)	+12V
7	GND	GND
8	GND	GND
9	GND	GND
10	GND	GND
11	GND	GND
12	GND	GND

P1 – Micro HDMI connector

PIN	SYMBOL	DESCRIPTION
1	DATA2+	TMDS Data2+
2	DATA2S	TMDS Data2 Shield
3	DATA2-	TMDS Data2-
4	DATA1+	TMDS Data1+
5	DATA1S	TMDS Data1 Shield
6	DATA1-	TMDS Data1-
7	DATA0+	TMDS Data0+
8	DATA0S	TMDS Data0 Shield
9	DATA0-	TMDS Data0-
10	CLK+	TMDS Clock+
11	CLK@	TMDS Clock Shield
12	CLK-	TMDS Clock-
13	CEC	CEC
14	NC	No connection
15	SCL	SCL (I ² C Serial Clock for DDC)
16	SDA	SDA (I ² C Serial Data Line for DDC)
17	CEC/GND	Ground
18	+5V	+5 V Power (max 50 mA)
19	HPDET	Hot Plug Detect

TROUBLESHOOTING

General

A general guide to troubleshooting a flat panel display system it is worth considering the system as separate elements, such as:

- Controller (jumpers, PC settings)
- Panel (controller, cabling, connection, panel, PC settings)
- Backlight (inverter, cabling, backlight tubes)
- Cabling
- Computer system (display settings, operating system)

Through step by step cross checking with instruction manuals and a process of elimination to isolate the problem it is usually possible to clearly identify the problem area.

No image:

- If the panel backlight is not working it may still be possible to just see some image on the display.
- A lack of image is most likely to be caused by incorrect connection, lack of power, failure to provide a signal or incorrect graphic card settings.

Image appearance:

- A faulty panel can have blank lines, failed sections, flickering or flashing display
- Incorrect graphics card refresh rate, resolution or interlaced mode will probably cause the image to be the wrong size, to scroll, flicker badly or possibly even no image.
- Incorrect jumper settings on the controller may cause everything from total failure to incorrect image. CAUTION: Do not set the panel power input incorrectly.
- Sparkling on the display: faulty panel signal cable.

Backlight:

Items to check include: Power input, Controls, Inverter and Tubes generally in this order.

If half the screen is dimmer than the other half:

- Check cabling for the inverter.
- For a specific backlight tube check the AC pins orientation (CAUTION: Never reverse any DC power pins).

Also:

- If adjusting brightness control has no effect the chances are that the VR rating or method of adjusting brightness is not compatible or correctly connected to the inverter.
- If system does not power down when there is a loss of signal

Continued failure:

If unit after unit keeps failing consider and investigate whether you are short circuiting the equipment or doing something else seriously wrong.

Generally after common sense issues have been resolved we recommend step by step substitution of known working parts to isolate the problem.

SPECIFICATIONS

Panel compatibility	1920x1200, 1920x1080, 1680x1050, 1600x1200, 1400x1050, 1440x900, 1366x768, 1280x1024, 1280x800, 1280x768, 1024x768, 1024x600, 800x600, 800x480, 640x480, 480x640 resolution TFT LVDS LCD's support.
No. of colours	Up to 3 x 8 bit providing 16.7 million colours.
Vertical refresh rate	WUXGA, UXGA, WXGA, SXGA, XGA, SVGA, VGA resolution up to 60Hz.
Dot clock (pixel clock) maximum	165 MHz
Graphics formats	Standard WUXGA, UXGA, SXGA, XGA, SVGA, VGA
Standard input at source	-Micro HDMI
Controls available	- On/Off - Brightness (inverter) - OSD menu - OSD select - OSD setting + - OSD setting -
Control interface	- Buttons, RS-232, IR remote control
Settings memory	Settings are stored in non volatile memory
Language OSD support	Graphics OSD icons
Voltage output for LCD	+3.3V, +5V, +12V The current drawn for 3.3V, 5V or 12V panel from 12VDC power input is limited to 3A.
Input voltage	12VDC , 5A max +/- 5%
Controller power consumption	Approx 4W (controller logic only, no panel and inverter are involved)
Controller dimensions	62.7mm x 91.4mm x 13.8mm
Storage temperature limits	-40°C to +70°C
Operating temperature limits	0°C to +60°C

NOTES

Please note the following:

- For specific panel setup a sample of an LCD may be required (this will be returned) and a copy of the full technical specifications for the panel from the manufacturer.
- Re-layout and custom development services are available.

Appendix I – Mode Support Table

Micro HDMI (P1) port :

Mode	Resolution	Clk [MHz]	Horizontal freq [KHz]	Vertical freq [Hz]
V_60	640x480 60Hz	25.175	31.469	59.940
SV_60	800x600 60Hz	40.000	37.879	60.317
X_60	1024x768 60Hz	65.000	48.363	60.004
SX_60	1280x1024 60Hz	108	63.81	60.020
UX_60	1600x1200 60Hz	162	75.000	60
WUX_60	1920x1080 60Hz	172.8	67.5	60
WUX_60	1920x1200 60Hz	193.2	74.5	60
1080p60	1920x1080p 60Hz	135	67.5	60
1080i60	1920x1080i 60Hz	74.14	33.7	60
1080i50	1920x1080i 50Hz	74.184	28.1	50
720p60	1280x720P 60Hz	74.25	45	60
576p50	720x576P 50Hz	26.9568	31.2	50
480p60	720x480P 60Hz	26.9568	31.4	60

Appendix II – RS-232 control protocols

RS-232 Serial control (Baud rate 2400, 8 bits, 1 stop bit and no parity)

Physical connection :

Controller side
Connector interface : CN8
Mating connector : Molex 51021-0600

Computer side
Connector interface : Serial port
Mating connector : DB9 Female

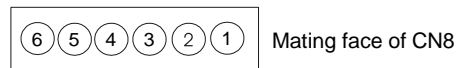

PIN#	Description
4	RS-232 Tx Data
5	Ground
6	RS-232 Rx Data

PIN#	Description
2	RS-232 Rx Data
3	RS-232 Tx Data
5	Ground

Software connection :

The OSD function can be controlled through sending the RS-232 protocol.

The RS-232 program can be custom-made to fit for application or it can be used the program provided by Digitalview on request. Please contact your local sales for informations.

1. Commands to implement switch mount control buttons

Function	Command	Description	Acknowledge (if enabled)
Menu	0xf7	Menu button pressed	Button equivalent
Select-down button	0xfa	Select down button pressed	Button equivalent
Select-up button	0xfb	Select up button pressed	Button equivalent
Right/+ button	0xfc	Right/+button pressed	Button equivalent
Left/- button	0xfd	Left/- button pressed	Button equivalent

2. Parameter setting - immediate, relative, reset and query

Function	Command	Description	Acknowledge (if enabled)
Brightness control	0x81, nn "+" "-" "r" "R" "?"	Set brightness = value/increment/decrement Reset Query	Brightness. Range: "0"0"-6"4" Default: "3"2"
Contrast control	0x82, "a" "A", nn "+" "-" "r" "R" "?"	Set all contrast = value/increment/decrement Reset Query	Contrast. Range: "4"0"-6"4" Default: "3"2"
Sharpness	0x8a, nn "+" "-" "r" "R" "?"	Set sharpness= value/increment/decrement Reset Query	Sharpness Range: "F"0"-0"4" Default: "0"0"
OSD H position	0x90, nnn "+" "-" "r" "R" "?"	Set osd_hpos = value/increment/decrement Reset Query	OSD horizontal position Range: "0"0"0"-3"E"8" Default: "1"F"4"
OSD V position	0x91, nnn "+" "-" "r" "R" "?"	Set osd_vpos = value/increment/decrement Reset Query	OSD vertical position Range: "0"0"0"-3"E"8" Default: "1"F"4"
Select menu	0x93,	Select menu timeout =	OSD menu timeout value.



timeout	nn "+" "-" "r" "R" "?"	value/increment/decrement Reset Query	"00" – Continuous. Value – Round up to nearest available step. If value > max available step, set it to the max available step. "0" "0" – Always On. "0" "C" – 12 seconds (Default) "0" "6" – 6 seconds "0" "3" – 3 seconds
GAMMA value select	0x9d, n "r" "R" "?"	Select GAMMA value = Value Reset Query	GAMMA value: "0" – 0.4, "1" – 0.6 "2" – 1.0 (Default), "3" – 1.6 "4" – 2.2
Colour temperature select	0xb3, n "r" "R" "?"	Select colour temperature = value Reset Query	Main selected. "0" – user defined RGB values. "1" – 4200K. "2" – 5000K. "3" – 6500K. "4" – 7500K. (Default) "5" – 9300K.
Red level for selected colour temperature	0xb4, nn "+" "-" "r" "R" "?"	Set the level of the red channel for the selected colour temp. = value/increment/decrement Reset Query	Red level for selected colour temperature. Range: "0" "0" – "6" "4" Default: "6" "4"
Green level for selected colour temperature	0xb5, nn "+" "-" "r" "R" "?"	Set the level of the green channel for the selected colour temp. = value/increment/decrement Reset Query	Green level for selected colour temperature. Range: "0" "0" – "6" "4" Default: "6" "4"
Blue level for selected colour temperature	0xb6, nn "+" "-" "r" "R" "?"	Set the level of the blue channel for the selected colour temp. = value/increment/decrement Reset Query	Blue level for selected colour temperature. Range: "0" "0" – "6" "4" Default: "6" "4"
Backlight brightness control	0xe0, nn "+" "-" "?"	Set backlight brightness = value/increment/decrement Query	Backlight brightness. Range: "0" "0" – "6" "4" e.g "1" "0" → 0xe0 0x31 0x30 * This control can only



			function when JB5 sets 3-4 closed * Apply for inverter control voltage in range of 0~5V. Each step interval is in 1
Backlight on/off control	0xe1, "0" "1" "r" "R" "?"	Set backlight brightness = Disable backlight Enable backlight Reset Query	Backlight on "1" / off "0". Default "1" = On
Backlight PWM**	0xe5, "0" "1" "?"	Set backlight type D/A or PWM Query	"1" – PWM "0" – D/A
Backlight PWM Frequency**	0xe6, nnn "+" "-" "?"	Set Backlight PWM Frequency = Value/ increment/ decrement Query	+/- 20Hz Value 100Hz : "0", "6", "4" 120Hz : "0", "7", "8" 140Hz : "0", "8", "C" 160Hz : "0", "A", "0" 180Hz : "0", "B", "4" 200Hz : "0", "C", "8" 220Hz : "0", "D", "C" 240Hz : "0", "F", "0" 260Hz : "1", "0", "4" 280Hz : "1", "1", "8" 300Hz : "1", "2", "C" 320Hz : "1", "4", "0" 340Hz : "1", "5", "4" 360Hz : "1", "6", "8" 380Hz : "1", "7", "C" 400Hz : "1", "9", "0" 420Hz : "1", "A", "4" 440Hz : "1", "B", "8"
Backlight Invert**	0xe7, 0" "1" "?"	Set backlight invert Normal or Invert Query	"1" – Invert "0" – Normal
OSD menu lock	0xf6, n "0" "1" "r" "R" "?"	OSD menu lock Off/ On Reset Query	"0" – OSD menu lock Off "1" – OSD menu lock On Default "0" = off

** - Only effective on V1.07.00 or version.



3. Other control

Function	Command	Description	Acknowledge (if enabled)
Select RS-232 acknowledge	0xc1, "0" "1"	Disable/enable command acknowledge.	"0" – acknowledge disabled. "1" – acknowledge enabled.
Command availability	0xc4, n	Check whether a command is available.	"0" – not available. "1" – available.
Soft Power On/Off**	0xc8, "0" "1" "?"	Soft power On/off query	"0" – soft power off. "1" –soft power on.
Query BIOS version	0xcb, "0"	Read BIOS version	"nnnn" = BIOS ver. "nn.nn"
Query PCBA number	0xcb, "1"	Read PCBA number	"nnnn" = PCBA number DD-1920="41730"
Load factory defaults	0xce	Reset all parameters to factory default value	"1" – successful.

** - Only effective on V1.07.00 or up version.

Hex to ASCII conversion table

Hex	ASCII	Hex	ASCII	Hex	ASCII	Hex	ASCII
0x30	0	0x41	A	0x61	a	0x2B	+
0x31	1	0x42	B	0x62	b	0x2D	-
0x32	2	0x43	C	0x63	c	0x3F	?
0x33	3	0x44	D	0x64	d		
0x34	4	0x45	E	0x65	e		
0x35	5	0x46	F	0x66	f		
0x36	6	0x47	G	0x67	g		
0x37	7	0x48	H	0x68	h		
0x38	8	0x49	I	0x69	i		
0x39	9	0x4A	J	0x6A	j		
		0x4B	K	0x6B	k		
		0x4C	L	0x6C	l		
		0x4D	M	0x6D	m		
		0x4E	N	0x6E	n		
		0x4F	O	0x6F	o		
		0x50	P	0x70	p		
		0x51	Q	0x71	q		
		0x52	R	0x72	r		
		0x53	S	0x73	s		
		0x54	T	0x74	t		
		0x55	U	0x75	u		
		0x56	V	0x76	v		
		0x57	W	0x77	w		
		0x58	X	0x78	x		
		0x59	Y	0x79	y		
		0x5A	Z	0x7A	z		

Appendix III – DDC/CI support at Micro HDMI port

This controller (start from V1.07.00 or later firmware revision) supports the following DDC/CI commands at Micro HDMI port :

- Brightness
- Contrast
- RGB Color
- Input Source (Micro HDMI)
- Power States (On, Standby, Sleep)
 - On mode: Always on. Display No sync message and never goes off when no signal
 - Standby mode: Off backlight & Off panel power when no signal
 - Reduced power off / Sleep mode: Screen saver on = Always On; Screen saver off = Backlight off. Display "No sync" message for 10sec, then off backlight

Appendix IV – Mapping definition

- Definition of Mapping A :

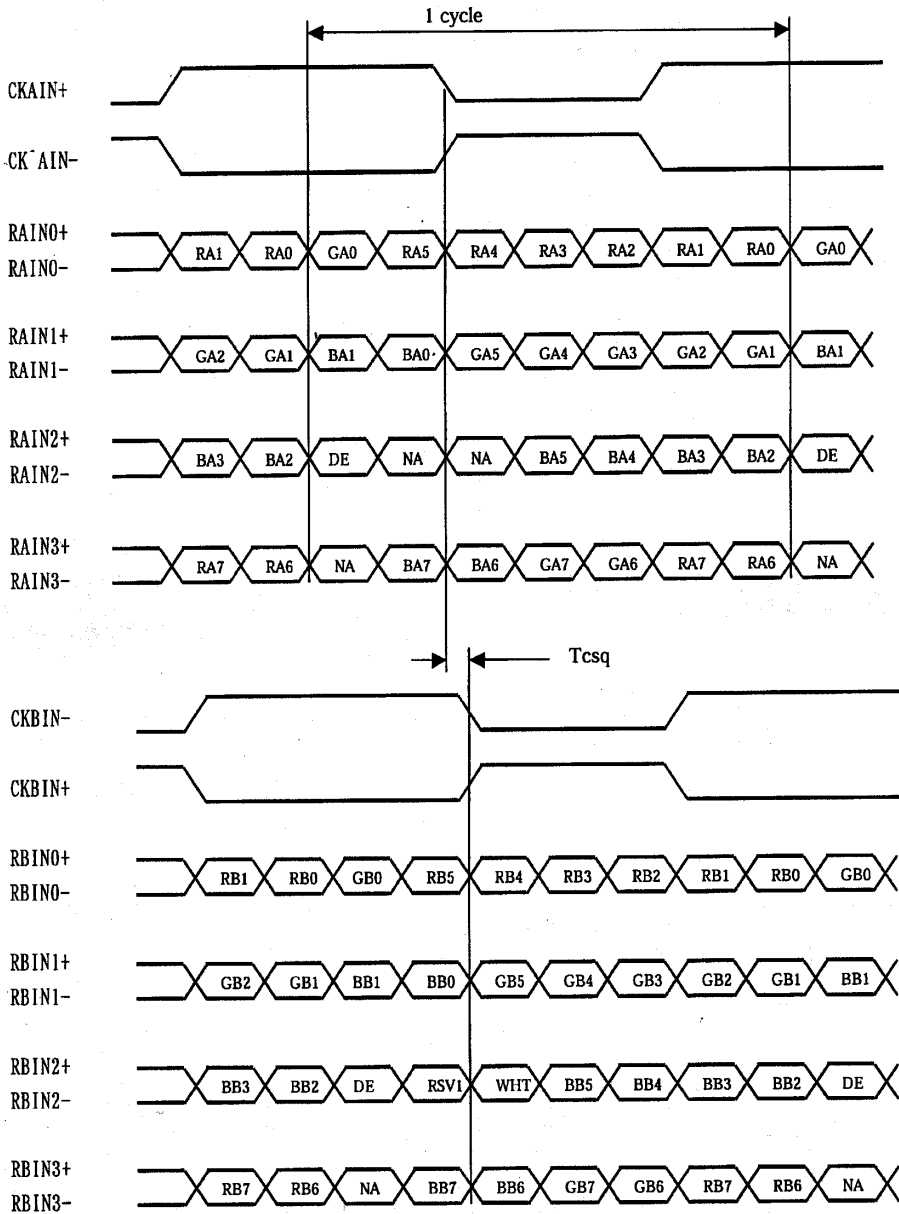

- Definition of Mapping B :

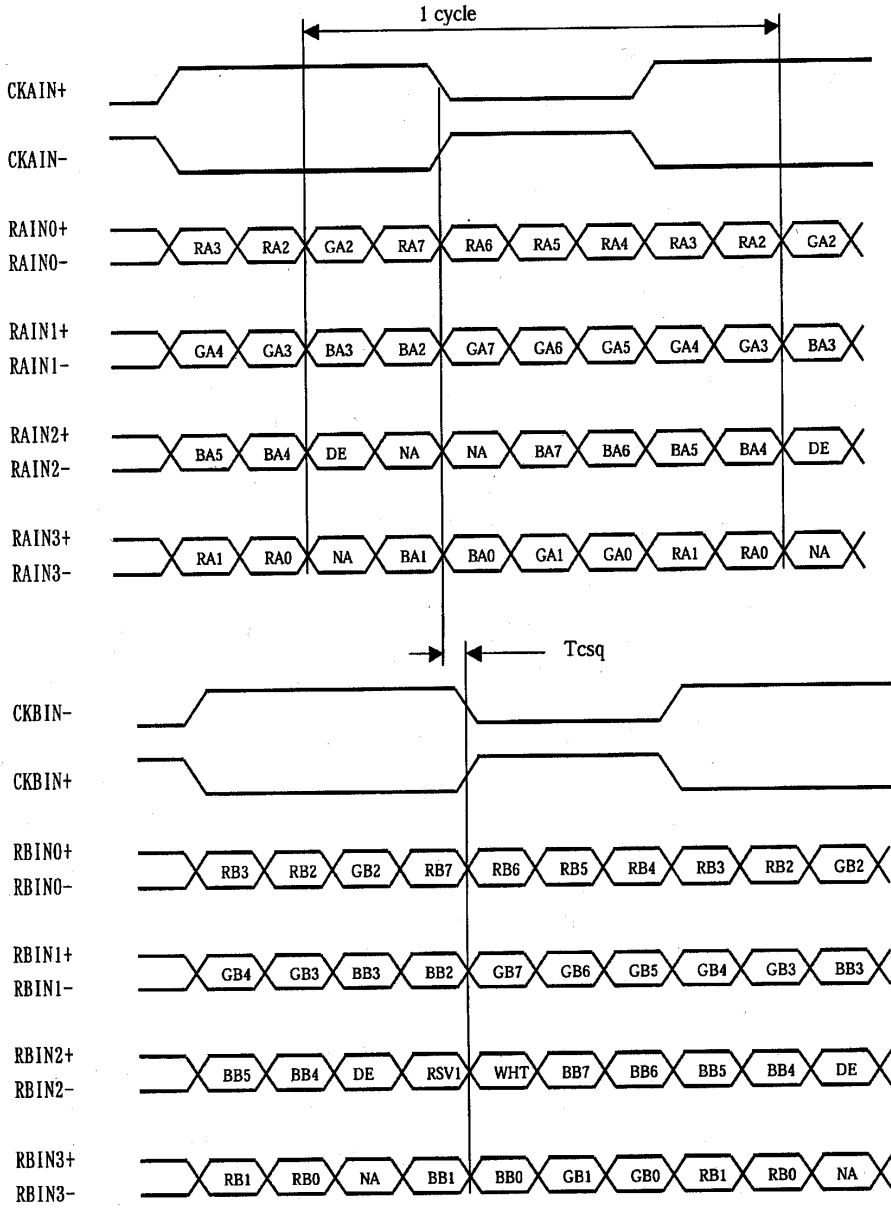

Appendix V – DV remote control unit work for DD-1920-HDMI-T

P/N 559000106-3 :

DigitalView remote control unit
(without DV logo silk screen
printing)

P/N 559000105-3 :

DigitalView remote control unit
(with DigitalView logo silk screen
printing)



BUTTON	FUNCTION
POWER BUTTON	Soft power ON/OFF button.
ATTENTION BUTTON	Use combined with digit keys to enable/disable the IR function. DD-1920-HDMI-T : "Attention" + "1"
MUTE BUTTON (M)	Switch to mute on/off mode.
SEL UP (▲) / SEL DN (▼)	Press this button to select the items in the OSD menu.
+ / - BUTTON	Use "+" button to direct control the hotkey function for switching to next input source. In OSD menu, pressing this button to adjust the settings.
DISPLAY BUTTON	Activate the OSD menu display on screen.
HDMI BUTTON	Press this button in the non OSD menu display mode to select HDMI source.

WARRANTY

The products are warranted against defects in workmanship and material for a period of three (3) year from the date of purchase provided no modifications are made to it and it is operated under normal conditions and in compliance with the instruction manual.

The warranty does not apply to:

- Product that has been installed incorrectly, this specifically includes but is not limited to cases where electrical short circuit is caused.
- Product that has been altered or repaired except by the manufacturer (or with the manufacturer's consent).
- Product that has subjected to misuse, accidents, abuse, negligence or unusual stress whether physical or electrical.
- Ordinary wear and tear.

Except for the above express warranties, the manufacturer disclaims all warranties on products furnished hereunder, including all implied warranties of merchantability and fitness for a particular application or purpose. The stated express warranties are in lieu of all obligations or liabilities on the part of the manufacturer for damages, including but not limited to special, indirect consequential damages arising out of or in connection with the use of or performance of the products.

CAUTION

Whilst care has been taken to provide as much detail as possible for use of this product it cannot be relied upon as an exhaustive source of information. This product is for use by suitably qualified persons who understand the nature of the work they are doing and are able to take suitable precautions and design and produce a product that is safe and meets regulatory requirements.

LIMITATION OF LIABILITY

The manufacturer's liability for damages to customer or others resulting from the use of any product supplied hereunder shall in no event exceed the purchase price of said product.

TRADEMARKS

The following are trademarks of Digital View Ltd:

- Digital View
- DD-1920-HDMI-T

CONTACT DETAILS

USA

Digital View Inc.
18440 Technology Drive
Building 130
Morgan Hill,
California, 95037
USA
Tel: (1) 408-782 7773 **Fax:** (1) 408-782 7883
Sales: ussales@digitalview.com

EUROPE

Digital View Ltd.
The Lake House
Knebworth Park
Herts, SG3 6PY
UK
Tel: +44-(0)20-7631-2150 **Fax:** +44-(0)20-7631-2156
Sales: uksales@digitalview.com

ASIA

Digital View Ltd
2nd Floor Bamboos Center
52 Hung To Road
Kwun Tong
Hong Kong
Tel: (852) 2861 3615 **Fax:** (852) 2520 2987
Sales: hksales@digitalview.com

WEBSITE

www.digitalview.com

Brand names belong to their respective owners. Specification subjects to change without notice.